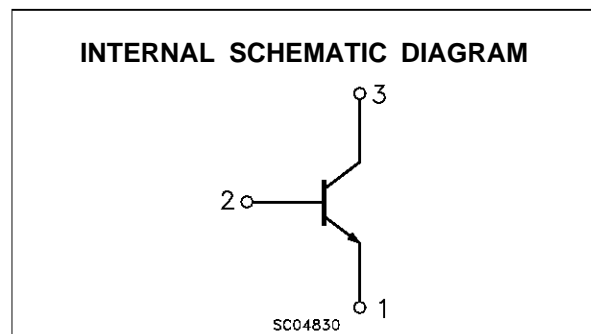
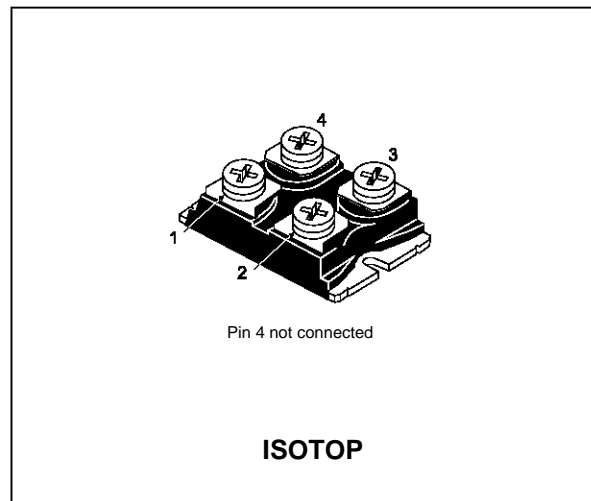

NPN TRANSISTOR POWER MODULE

- HIGH CURRENT POWER BIPOLAR MODULE
- VERY LOW R_{th} JUNCTION CASE
- SPECIFIED ACCIDENTAL OVERLOAD AREAS
- ISOLATED CASE (2500V RMS)
- EASY TO MOUNT
- LOW INTERNAL PARASITIC INDUCTANCE

INDUSTRIAL APPLICATIONS:

- MOTOR CONTROL
- SMPS & UPS
- WELDING EQUIPMENT

ABSOLUTE MAXIMUM RATINGS

Symbol	Parameter	Value	Unit
V_{CEV}	Collector-Emitter Voltage ($V_{BE} = -5\text{ V}$)	1000	V
$V_{CEO(sus)}$	Collector-Emitter Voltage ($I_B = 0$)	450	V
V_{EBO}	Emitter-Base Voltage ($I_C = 0$)	7	V
I_C	Collector Current	50	A
I_{CM}	Collector Peak Current ($t_p = 10\text{ ms}$)	75	A
I_B	Base Current	10	A
I_{BM}	Base Peak Current ($t_p = 10\text{ ms}$)	16	A
P_{tot}	Total Dissipation at $T_c = 25\text{ }^\circ\text{C}$	250	W
T_{stg}	Storage Temperature	-55 to 150	$^\circ\text{C}$
T_j	Max. Operating Junction Temperature	150	$^\circ\text{C}$
V_{iso}	Insulation Withstand Voltage (AC-RMS)	2500	$^\circ\text{C}$

THERMAL DATA

$R_{thj-case}$	Thermal Resistance Junction-case	Max	0.5	°C/W
R_{thc-h}	Thermal Resistance Case-heatsink With Conductive Grease Applied	Max	0.05	°C/W

ELECTRICAL CHARACTERISTICS ($T_{case} = 25\text{ °C}$ unless otherwise specified)

Symbol	Parameter	Test Conditions	Min.	Typ.	Max.	Unit
I_{CER}	Collector Cut-off Current ($R_{BE} = 5\ \Omega$)	$V_{CE} = V_{CEV}$ $V_{CE} = V_{CEV}$ $T_j = 100\text{ °C}$			0.4 2	mA mA
I_{CEV}	Collector Cut-off Current ($V_{BE} = -5V$)	$V_{CE} = V_{CEV}$ $V_{CE} = V_{CEV}$ $T_j = 100\text{ °C}$			0.4 2	mA mA
I_{EBO}	Emitter Cut-off Current ($I_C = 0$)	$V_{EB} = 5\ V$			2	mA
$V_{CE0(SUS)}^*$	Collector-Emitter Sustaining Voltage	$I_C = 0.2\ A$ $L = 25\ mH$ $V_{clamp} = 450\ V$	450			V
h_{FE}^*	DC Current Gain	$I_C = 32\ A$ $V_{CE} = 5\ V$		12		
$V_{CE(sat)}^*$	Collector-Emitter Saturation Voltage	$I_C = 32\ A$ $I_B = 6.4\ A$ $I_C = 32\ A$ $I_B = 6.4\ A$ $T_j = 100\text{ °C}$		0.35 0.6	1.2 2	V V
$V_{BE(sat)}^*$	Base-Emitter Saturation Voltage	$I_C = 32\ A$ $I_B = 6.4\ A$ $I_C = 32\ A$ $I_B = 6.4\ A$ $T_j = 100\text{ °C}$		1 0.9	1.5 1.5	V V
di_C/dt	Rate of Rise of On-state Collector	$V_{CC} = 300\ V$ $R_C = 0$ $t_p = 3\ \mu s$ $I_{B1} = 9.6\ A$ $T_j = 100\text{ °C}$	160	210		A/ μs
$V_{CE(3\ \mu s)}$	Collector-Emitter Dynamic Voltage	$V_{CC} = 300\ V$ $R_C = 9.3\ \Omega$ $I_{B1} = 9.6\ A$ $T_j = 100\text{ °C}$		4.5	8	V
$V_{CE(5\ \mu s)}$	Collector-Emitter Dynamic Voltage	$V_{CC} = 300\ V$ $R_C = 9.3\ \Omega$ $I_{B1} = 9.6\ A$ $T_j = 100\text{ °C}$		2.5	4	V
t_s	Storage Time	$I_C = 32\ A$ $V_{CC} = 50\ V$		3.2	4.5	μs
t_f	Fall Time	$V_{BB} = -5\ V$ $R_{BB} = 0.39\ \Omega$		0.25	0.4	μs
t_c	Cross-over Time	$V_{clamp} = 450\ V$ $I_{B1} = 6.4\ A$ $L = 78\ \mu H$ $T_j = 100\text{ °C}$		0.5	0.7	μs
V_{CEW}	Maximum Collector Emitter Voltage Without Snubber	$I_{Cwoff} = 48\ A$ $I_{B1} = 6.4\ A$ $V_{BB} = -5\ V$ $V_{CC} = 50\ V$ $L = 52\ \mu H$ $R_{BB} = 0.39\ \Omega$ $T_j = 125\text{ °C}$	450			V

* Pulsed: Pulse duration = 300 μs , duty cycle 1.5 %

Safe Operating Areas

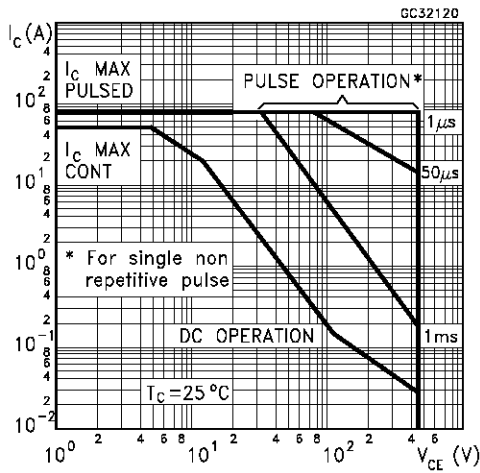

Thermal Impedance

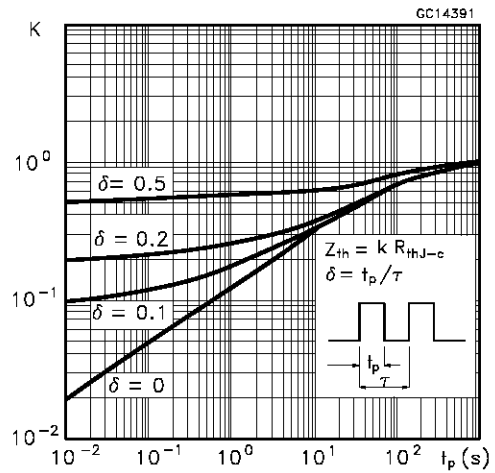

Derating Curve

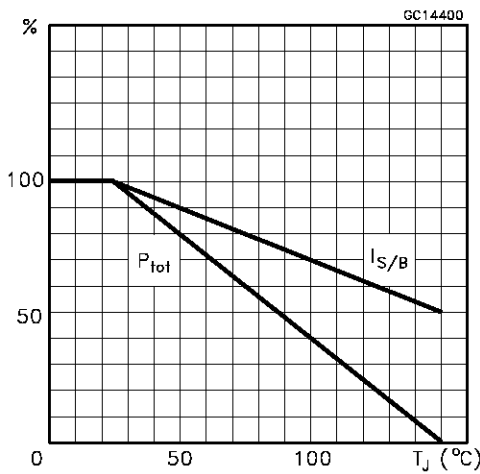

Collector-emitter Voltage Versus base-emitter Resistance

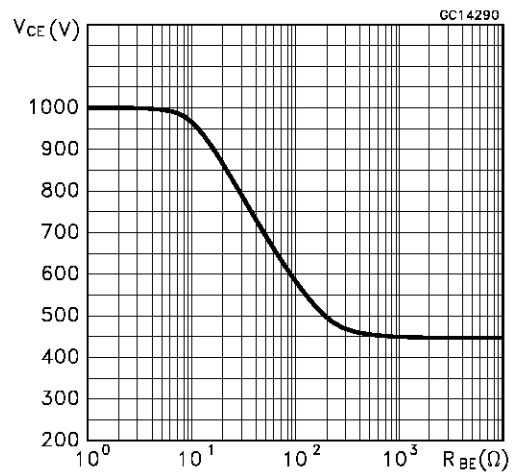

Collector Emitter Saturation Voltage

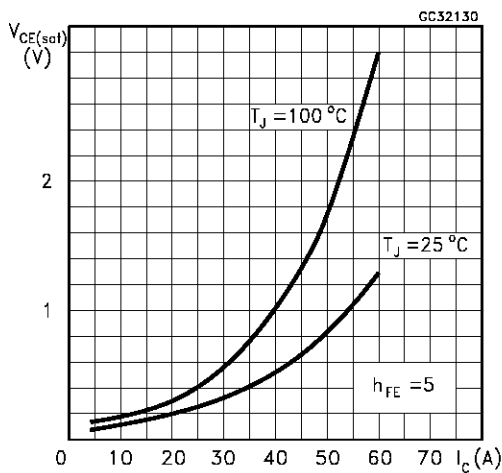

Base-Emitter Saturation Voltage

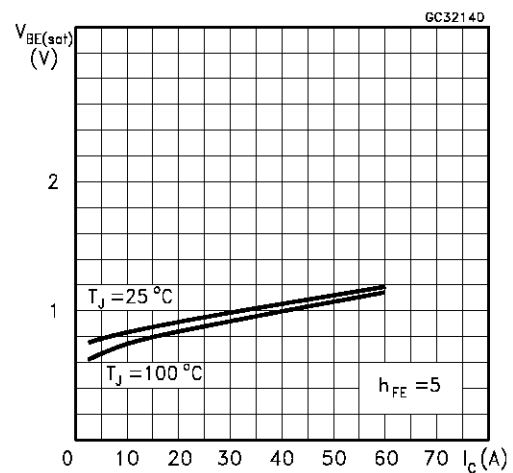

Reverse Biased SOA

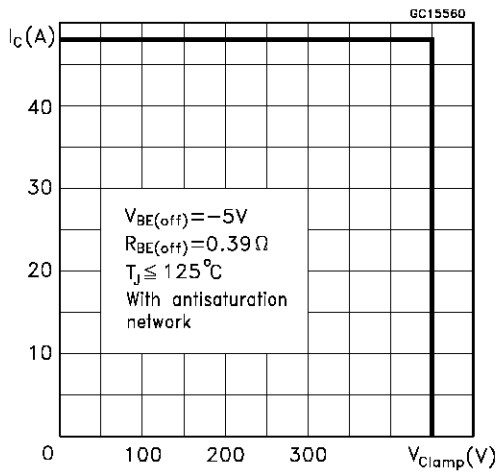

Forward Biased SOA

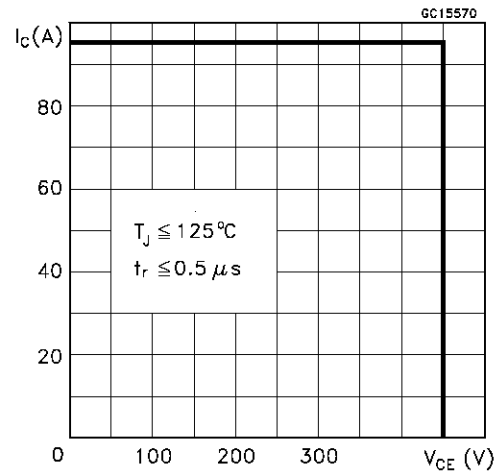

Reverse Biased AOA

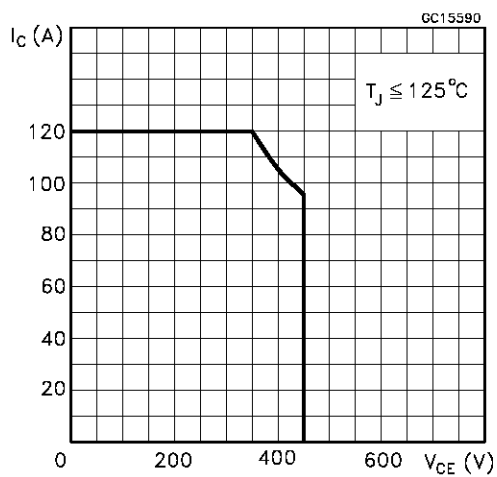

Forward Biased AOA

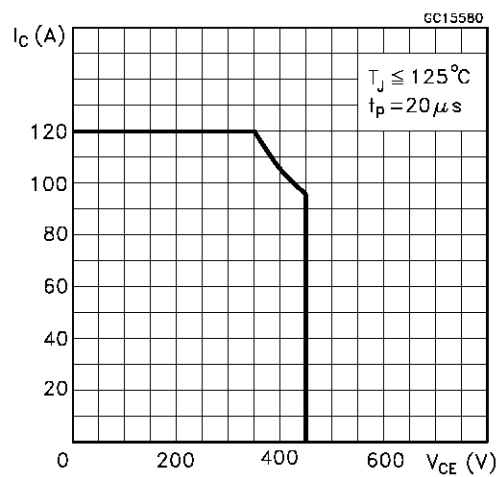

Switching Times Inductive Load

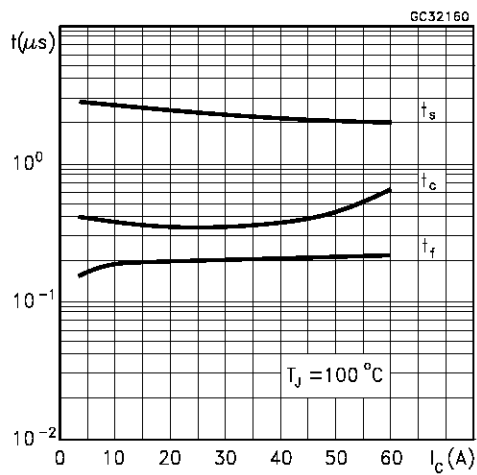

Switching Times Inductive Load Versus Temperature

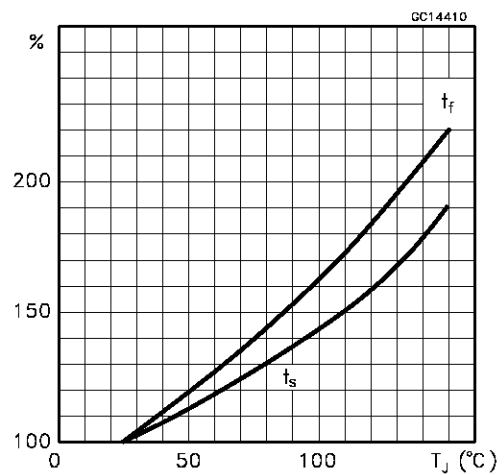

Dc Current Gain

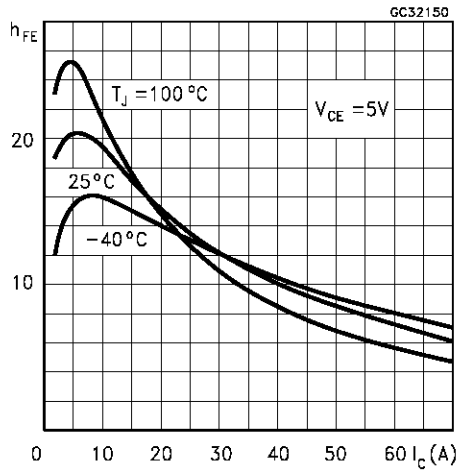

Turn-on Switching Test Circuit

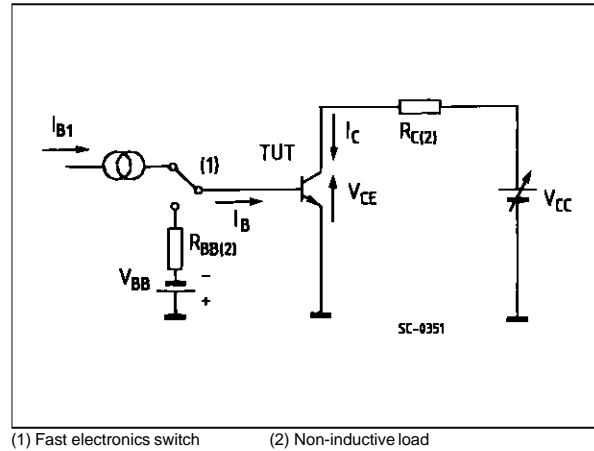

Turn-on Switching Waveforms

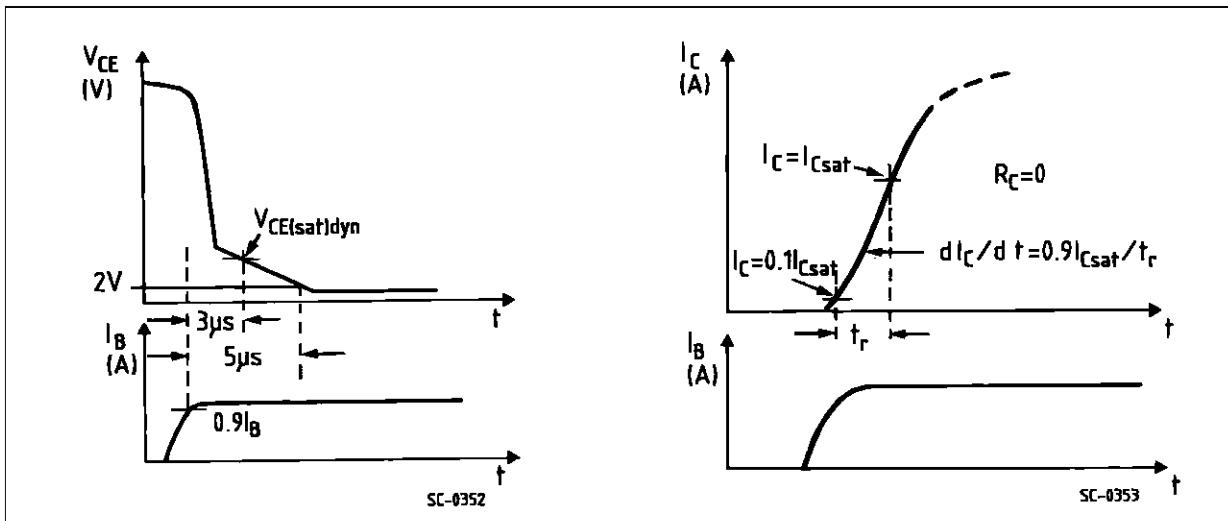

Turn-off Switching Test Circuit

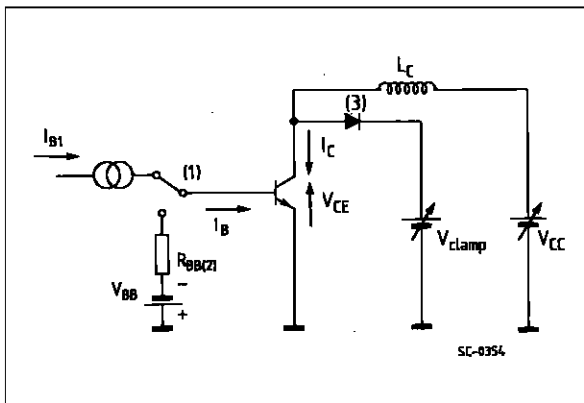

Turn-off Switching Waveforms

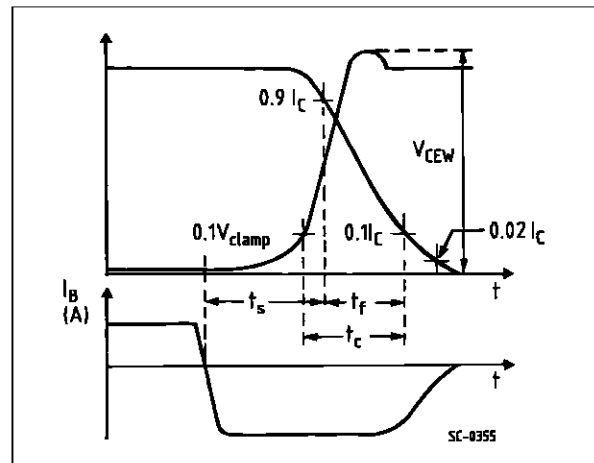

ISOTOP MECHANICAL DATA

DIM.	mm			inch		
	MIN.	TYP.	MAX.	MIN.	TYP.	MAX.
A	11.8		12.2	0.466		0.480
B	8.9		9.1	0.350		0.358
C	1.95		2.05	0.076		0.080
D	0.75		0.85	0.029		0.033
E	12.6		12.8	0.496		0.503
F	25.15		25.5	0.990		1.003
G	31.5		31.7	1.240		1.248
H	4			0.157		
J	4.1		4.3	0.161		0.169
K	14.9		15.1	0.586		0.594
L	30.1		30.3	1.185		1.193
M	37.8		38.2	1.488		1.503
N	4			0.157		
O	7.8		8.2	0.307		0.322

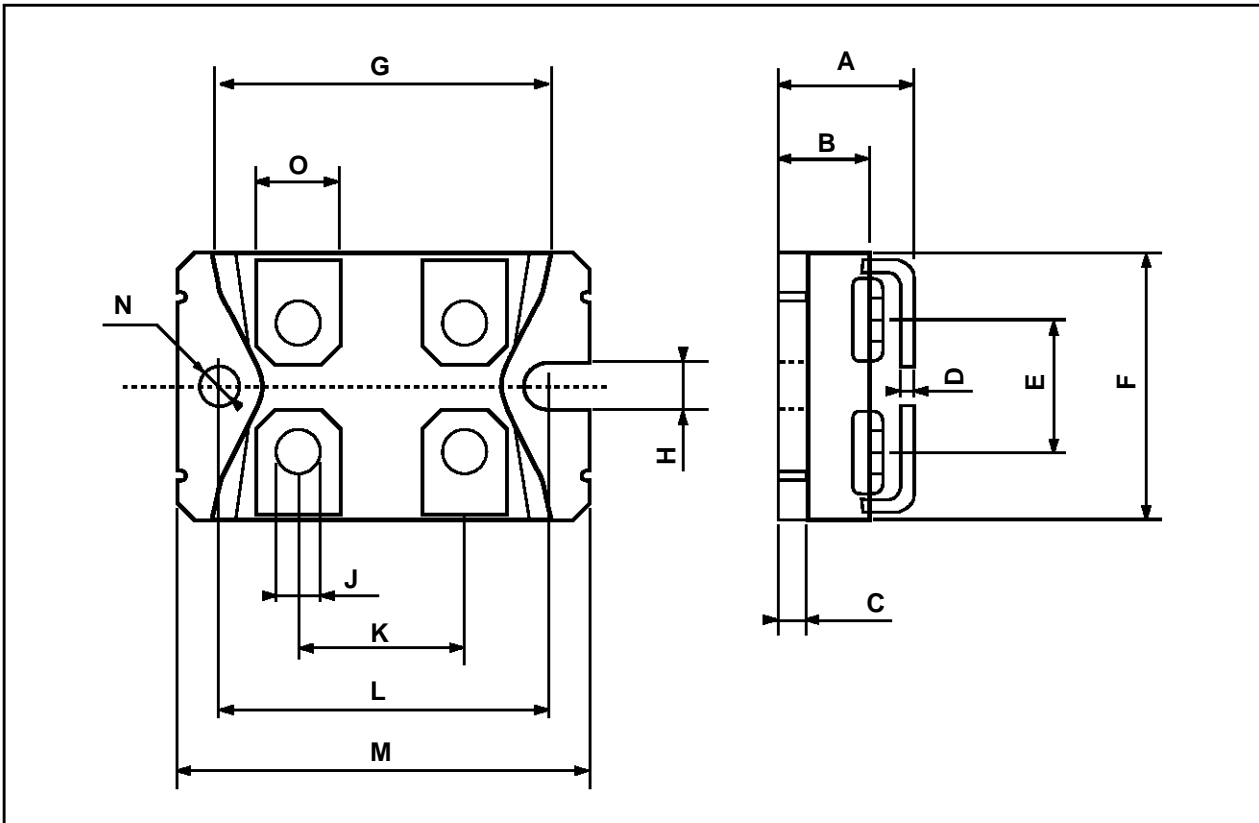

Information furnished is believed to be accurate and reliable. However, SGS-THOMSON Microelectronics assumes no responsibility for the consequences of use of such information nor for any infringement of patents or other rights of third parties which may result from its use. No license is granted by implication or otherwise under any patent or patent rights of SGS-THOMSON Microelectronics. Specifications mentioned in this publication are subject to change without notice. This publication supersedes and replaces all information previously supplied. SGS-THOMSON Microelectronics products are not authorized for use as critical components in life support devices or systems without express written approval of SGS-THOMSON Microelectronics.

© 1997 SGS-THOMSON Microelectronics - Printed in Italy - All Rights Reserved

SGS-THOMSON Microelectronics GROUP OF COMPANIES
Australia - Brazil - Canada - China - France - Germany - Hong Kong - Italy - Japan - Korea - Malaysia - Malta - Morocco - The Netherlands -
Singapore - Spain - Sweden - Switzerland - Taiwan - Thailand - United Kingdom - U.S.A
...